

Data Sheet

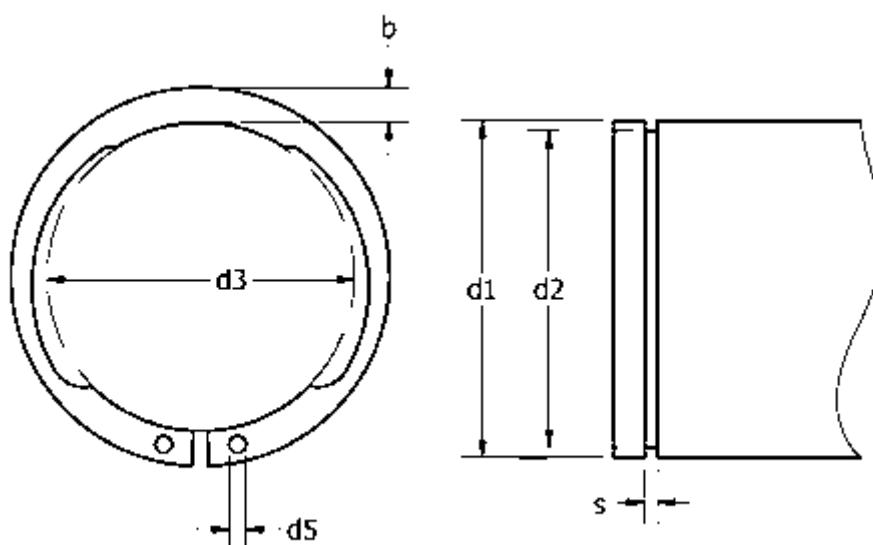

Article number: 0105049
 Description: Retaining ring AV 32
 Note: Fitted with ZGA pliers

Measures



AN mm ²	= 37.0	FRg kN	= 4.7	t	= 0.85
b	= 4.0	FR kN	= 27.0	tol	= -0.06
d1	= 32	g	= 2.0	tol	= -0.25
d2	= 30.3	K kN-mm	= 52.0	tol	= +0,21-0,42
d3	= 29.60	m min	= 1.60	tol	= 0.1
d5 min	= 2.0	n abl x 1000	= 17	Tong	= ZGA-2
Description	= AV 32	s	= 1.50	Weight kg/1000	= 3.88
FN kN	= 6.25	Side power N at I2	= 2.5		